

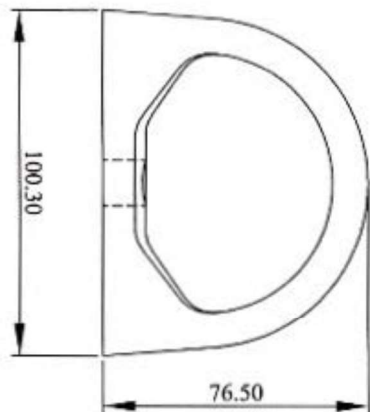

FA 60 014 00, FA 60 014 01

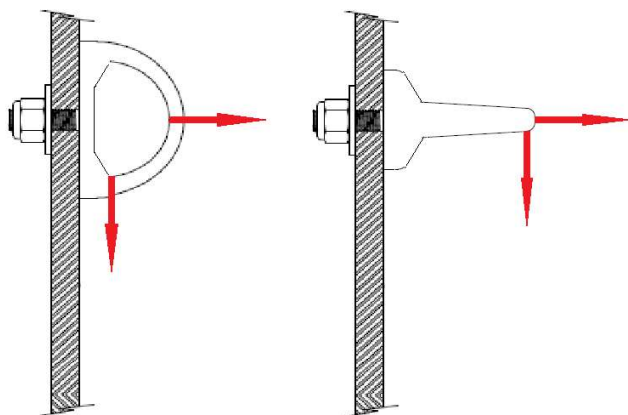

Ø M12

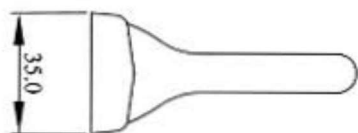

10 mm

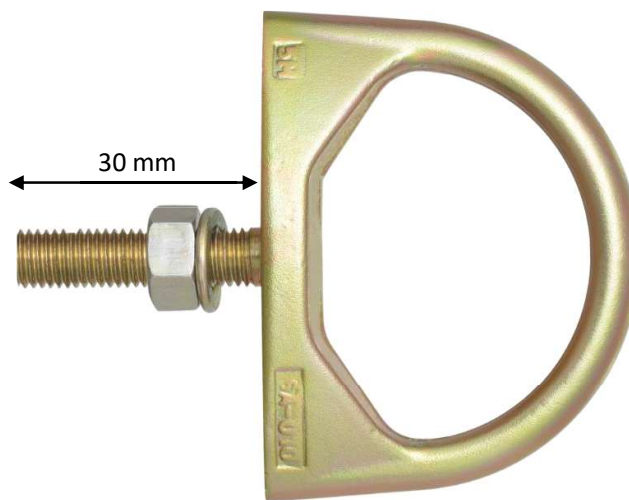





FA 60 014 00



FA 60 014 01



HS CODE
73269098
CARTON SIZE / PCS.
40 x 30 x 15 cm / 50
FA 60 014 00: Certificate of Test n° SPC0255511/1712/2 Issue 2 Ext. 1 - FA 60 014 01: Certificate of Test n° SPC0255511/1712/1 Issue 4 Ext. 1
Satra Technology Centre, N°0321 Wyndham Way, Telford Way, Kettering Northamptonshire, NN16 8SD, United Kingdom

REF.	FA 60 014 00	FA 60 014 01
CE	EN 795:2012 Type A TS 16415:2013 Type A	EN 795:2012 Type A TS 16415:2013 Type A
	x4	x4
MAT.		
DIM.	100 x 76 mm	100 x 76 mm
R (kN) / MBS (kN)	12 kN / 23 kN	12 kN / 23 kN
	M12 Ø 13 mm x 10 mm	---
	0.53 KG	0.37 KG



Nombre d'utilisateurs
Number of users
Cantidad de usuarios
Quantità di utilizzatori
Anzahl der Benutzer

R (kN) / MBS (kN)

Résistance statique (en kN) / Résistance à la rupture
Static strength / Minimum Breaking Strength
Resistencia estática (en kN) / Resistencia a la ruptura (en kN)
Resistenza statica (in kN) / Resistenza alla rottura (in kN)
Statische Festigkeit (in kN) / Bruchfestigkeit (in kN)



Fixations à utiliser / Dimensions de la structure d'accueil
Fasteners to use / Dimensions of the receiving structure
Fijaciones que deben usarse / Dimensiones de la estructura receptora
Elementi di fissaggio da utilizzare / Dimensioni della struttura ospitante
Zu verwendende Befestigungen / Abmessungen der Aufnahmestruktur